

## MPSA55

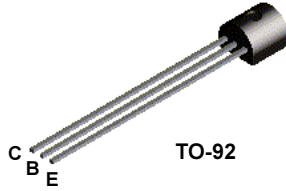

## MMBTA55

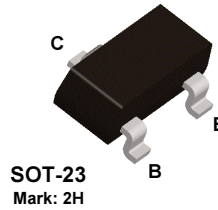

## PZTA55

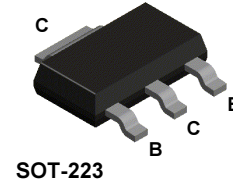

## PNP General Purpose Amplifier

This device is designed for general purpose amplifier applications at collector currents to 300 mA. Sourced from Process 73. See MPSA56 for characteristics.

### Absolute Maximum Ratings\*

TA = 25°C unless otherwise noted

Symbol	Parameter	Value	Units
V <sub>CE</sub>	Collector-Emitter Voltage	60	V
V <sub>CB</sub> O	Collector-Base Voltage	60	V
V <sub>EB</sub> O	Emitter-Base Voltage	4.0	V
I <sub>C</sub>	Collector Current - Continuous	500	mA
T <sub>J</sub> , T <sub>stg</sub>	Operating and Storage Junction Temperature Range	-55 to +150	°C

\*These ratings are limiting values above which the serviceability of any semiconductor device may be impaired.

#### NOTES:

- 1) These ratings are based on a maximum junction temperature of 150 degrees C.
- 2) These are steady state limits. The factory should be consulted on applications involving pulsed or low duty cycle operations.

### Thermal Characteristics

TA = 25°C unless otherwise noted

Symbol	Characteristic	Max			Units
		MPSA55	*MMBTA55	**PZTA55	
P <sub>D</sub>	Total Device Dissipation	625	350	1,000	mW
	Derate above 25°C	5.0	2.8	8.0	mW/°C
R <sub>θJC</sub>	Thermal Resistance, Junction to Case	83.3			°C/W
R <sub>θJA</sub>	Thermal Resistance, Junction to Ambient	200	357	125	°C/W

\* Device mounted on FR-4 PCB 1.6" X 1.6" X 0.06."

\*\* Device mounted on FR-4 PCB 36 mm X 18 mm X 1.5 mm; mounting pad for the collector lead min. 6 cm<sup>2</sup>.

## PNP General Purpose Amplifier

(continued)

### Electrical Characteristics

TA = 25°C unless otherwise noted

Symbol	Parameter	Test Conditions	Min	Max	Units
--------	-----------	-----------------	-----	-----	-------

#### OFF CHARACTERISTICS

$V_{(BR)CEO}$	Collector-Emitter Breakdown Voltage*	$I_C = 1.0 \text{ mA}, I_B = 0$	60		V
$V_{(BR)CBO}$	Collector-Base Breakdown Voltage	$I_C = 100 \text{ } \mu\text{A}, I_E = 0$	60		V
$V_{(BR)EBO}$	Emitter-Base Breakdown Voltage	$I_E = 100 \text{ } \mu\text{A}, I_C = 0$	4.0		V
$I_{CEO}$	Collector-Cutoff Current	$V_{CE} = 60 \text{ V}, I_B = 0$		0.1	$\mu\text{A}$
$I_{CBO}$	Collector-Cutoff Current	$V_{CB} = 60 \text{ V}, I_E = 0$		0.1	$\mu\text{A}$

#### ON CHARACTERISTICS

$h_{FE}$	DC Current Gain	$I_C = 10 \text{ mA}, V_{CE} = 1.0 \text{ V}$ $I_C = 100 \text{ mA}, V_{CE} = 1.0 \text{ V}$	100		
$V_{CE(sat)}$	Collector-Emitter Saturation Voltage	$I_C = 100 \text{ mA}, I_B = 10 \text{ mA}$		0.25	V
$V_{BE(on)}$	Base-Emitter On Voltage	$I_C = 100 \text{ mA}, V_{CE} = 1.0 \text{ V}$		1.2	V

#### SMALL SIGNAL CHARACTERISTICS

$f_T$	Current Gain - Bandwidth Product	$I_C = 100 \text{ mA}, V_{CE} = 1.0 \text{ V},$ $f = 100 \text{ MHz}$	50		MHz
-------	----------------------------------	--	----	--	-----

\*Pulse Test: Pulse Width  $\leq 300 \text{ } \mu\text{s}$ , Duty Cycle  $\leq 2.0\%$

MPSA55 / MM5TA55 / PZTA55

# TO-92 Tape and Reel Data



## TO-92 Packaging Configuration: Figure 1.0

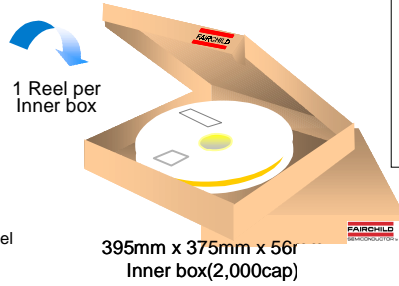
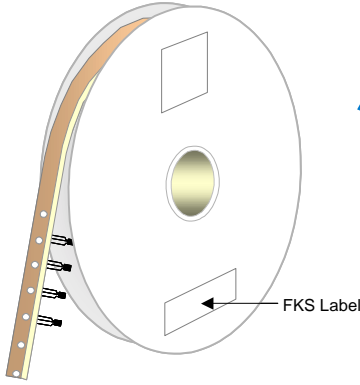

### Packaging Description:

TO-92 parts are shipped normally in tape. These reeled parts in standard option are shipped with 2,000 units per 14" or 355.6cm diameter reel. This and some other options are further described in the Packaging Information table. These full reels are individually barcode labeled and placed inside a standard intermediate box (illustrated in figure 1.0) made of recyclable corrugated brown paper. One box contains one reel maximum. And these boxes are placed inside a barcode labeled shipping box which comes in different sizes depending on the number of parts shipped.

## TO-92 Packaging Configuration: Figure 2.0

TO-92 Packaging Information			
Packaging Option	Standard (no flow code)	Standard (no flow code)	Standard (no flow code)
Packaging type	TNR	AMMO	BULK
Qty per Reel/Tube/ Bag	2,000	-	1,000
Reel Size	14" Dia	-	-
Inner Box Dimension (mm)	395x375x56	328x162x43	237x167x96
Max qty per Box	2,000	2,000	10,000
Outer Box Dimension (mm)	420x420x320	525x360x265	525x360x265
Max qty per Box	10,000	30,000	100,000
Weight per unit (gm)	0.2080	0.2080	0.2080
Note/Comments			

### Inner Box Bar Code Label Sample



### Outer Box Bar Code Label Sample

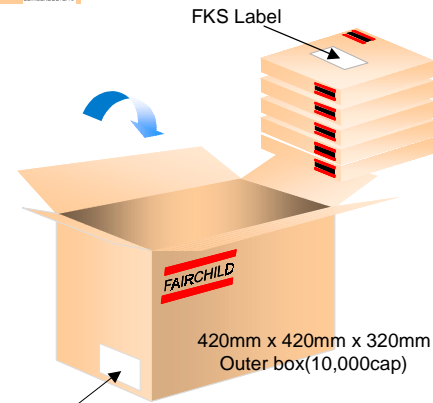

## TO-92 AMMO Packaging Configuration: Figure 3.0

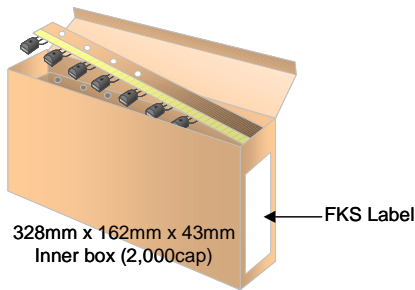

15 Ammo boxes per Outer Box

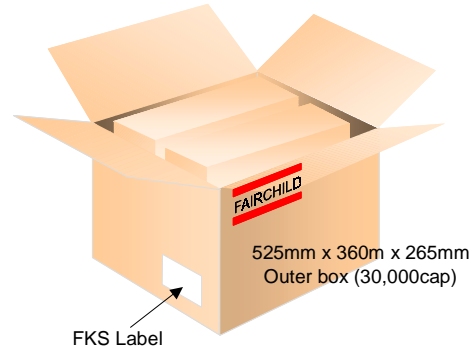

## TO-92 Bulk Packing Configuration: Figure 4.0

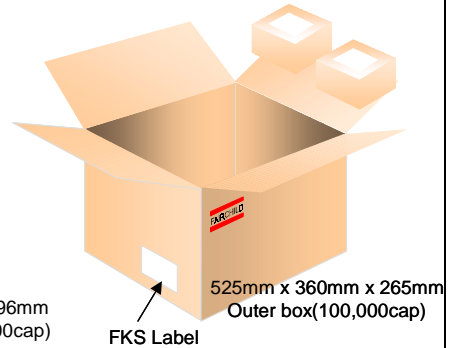

## TO-92 Tape and Reel Data, continued

### TO-92 Reeling Style

Configuration: Figure 5.0

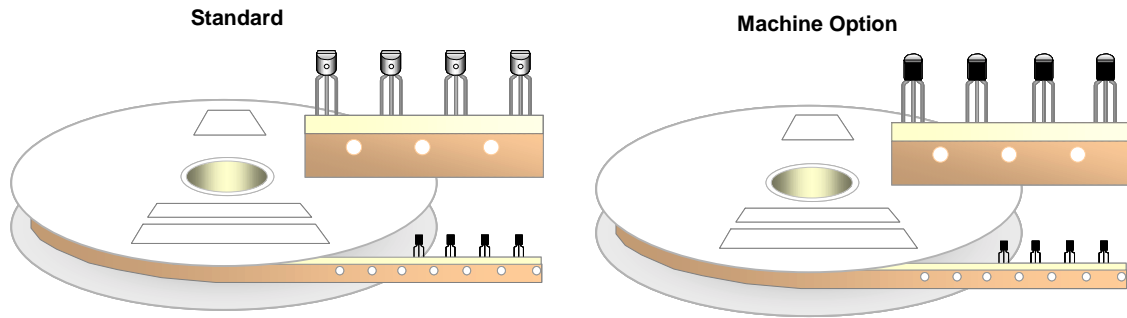

### TO-92 Radial Ammo Packaging

Configuration: Figure 6.0

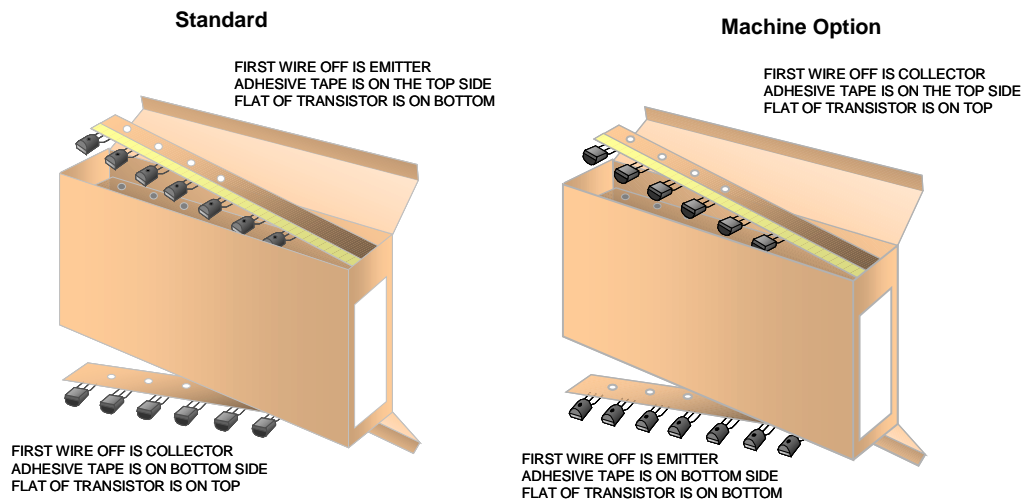

# TO-92 Tape and Reel Data, continued

**TO-92 Tape and Reel Taping  
Dimension Configuration: Figure 7.0**

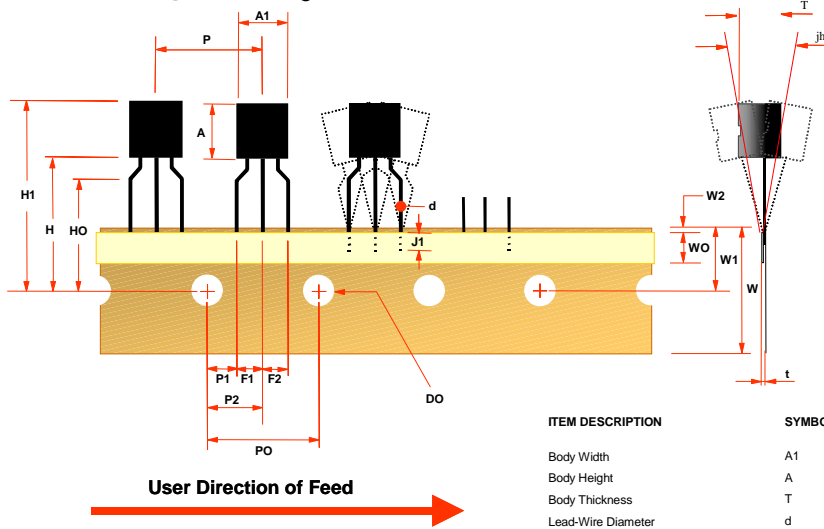

ITEM DESCRIPTION	SYMBOL	DIMENSION	REMARK
Body Width	A1	4.58 (+ 0.25, - 0.15)	
Body Height	A	4.58 (+/- 0.20)	
Body Thickness	T	3.86 (max)	
Lead-Wire Diameter	d	0.46 (+/- 0.05)	
Pitch of Component	P	12.7 (+/- 0.50)	
Feed Hole Pitch	P0	12.7 (+/- 0.20)	
Hole Center to Component Center	P2	6.35 (+/- 0.50)	In Case of Reel Package +/- 1.00
Lead to Lead Distance	F1,F2	2.50 (+ 0.3, - 0.10)	F1-F2= +/- 0.30
Component Alignment F-R	jh	0.00 (+/- 1.00)	
Tape Width	W	18.00 (+ 1.00, - 0.50)	
Hole-Down Tape Width	W0	6.00 (+/- 0.50)	
Hole Position	W1	9.00 (+/- 0.50)	
Hole-Down Tape Position	W2	1.00 (max)	
Height of Component From Tape Center	H	19.50 (+/- 1.00)	H + A <= H1
Lead-Wire Clinch Height	H0	16.00 (+/- 0.50)	
Component Height	H1	27.0 (max)	
Lead-Wire (Tape Portion)	J1	2.50 (min)	
Feed Hole Diameter	D0	4.00 (+/- 0.20)	
Total Tape Thickness	t	0.65 (+/- 0.20)	
Position of Hole	P1	3.85 (+/- 0.50)	

Note : All dimensions are in millimeters.

**TO-92 Reel  
Configuration: Figure 8.0**

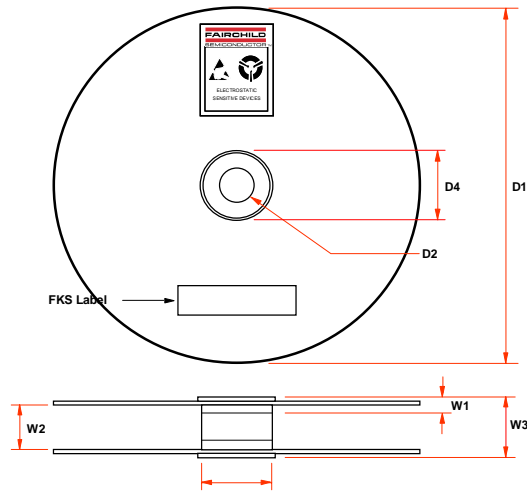

ITEM DESCRIPTION	SYMBOL	MINIMUM	MAXIMUM
Reel Diameter	D1	13.975	14.025
Arbor Hole Diameter (Standard)	D2	1.160	1.200
(Small Hole)	D2	0.650	0.700
Core Diameter	D3	3.100	3.300
Hub Recess Inner Diameter	D4	2.700	3.100
Hub Recess Depth	W1	0.370	0.570
Flange to Flange Inner Width	W2	1.630	1.690
Hub to Hub Center Width	W3		2.090

Note: All dimensions are in inches

# TO-92 Package Dimensions



## TO-92 (FS PKG CODE AM)

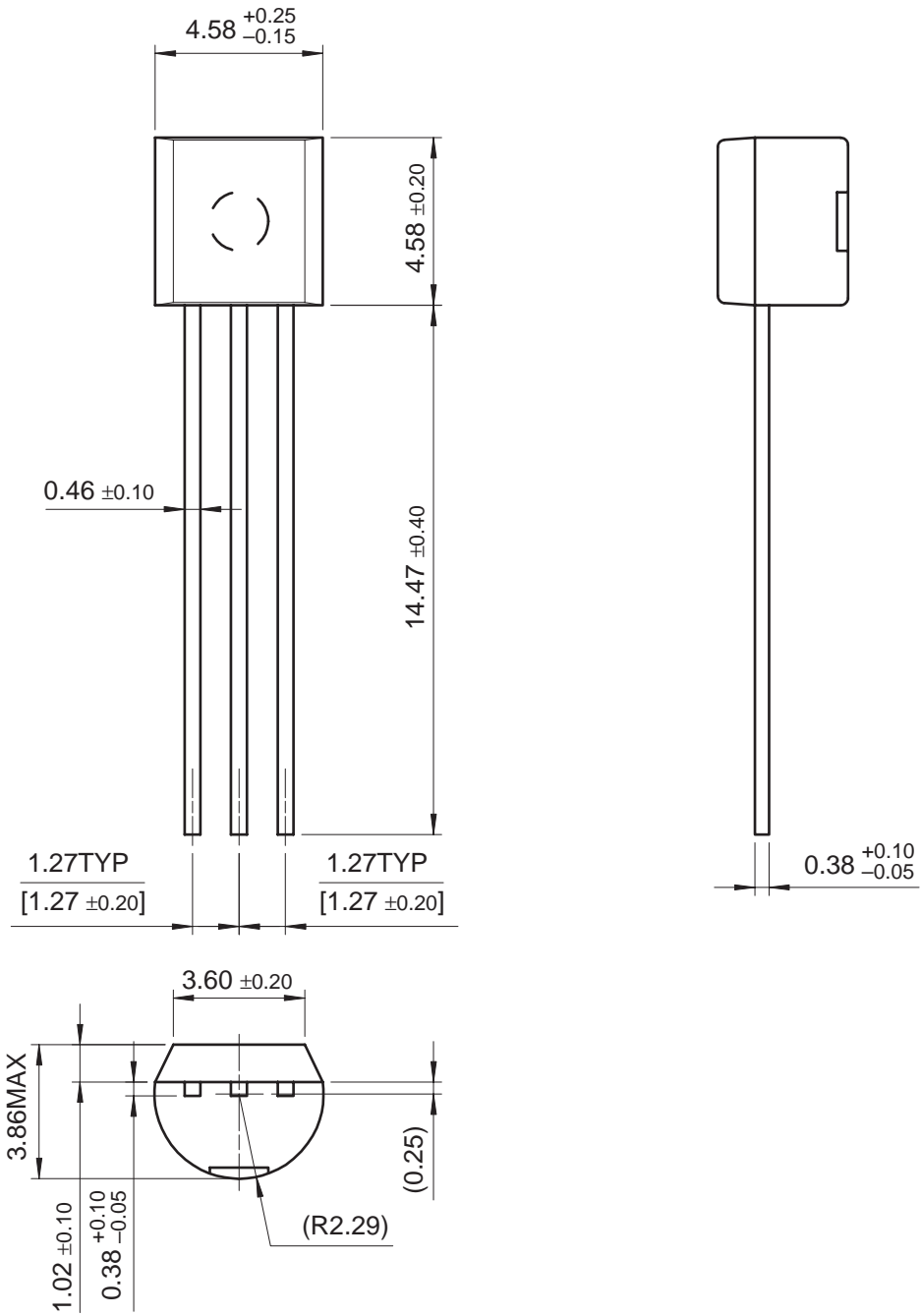

Dimensions in Millimeters

August 1999, Rev B

# SOT-23 Tape and Reel Data



SOT-23 Packaging Configuration: Figure 1.0

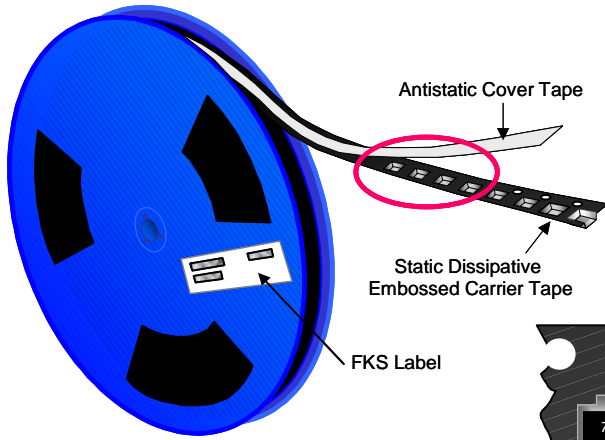

**Packaging Description:**

SOT-23 parts are shipped in tape. The carrier tape is made from a dissipative (carbon filled) polycarbonate resin. The cover tape is a multilayer film (Heat Activated Adhesive in nature) primarily composed of polyester film, adhesive layer, sealant, and anti-static sprayed agent. These reeled parts in standard option are shipped with 3,000 units per 7" or 17.7cm diameter reel. The reels are clear in color and is made of polystyrene plastic (anti-static coated). This and some other options are further described in the Packaging Information table. These full reels are individually barcode labeled and placed inside a standard intermediate box (illustrated in figure 1.0) made of recyclable corrugated brown paper. One box contains five reels maximum. And these boxes are placed inside a barcode labeled shipping box which comes in different sizes depending on the number of parts shipped.

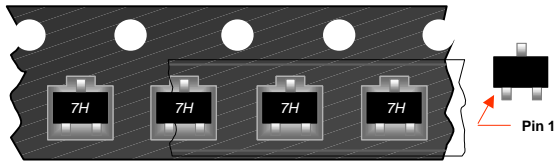

**SOT-23 Unit Orientation**

SOT-23 Packaging Information	
Packaging Option	Standard
Packaging type	TNR
Qty per Reel/Tube/Bag	3,000
Reel Size	7" Dia
Inner Box Dimension (mm)	188x181x69
Max qty per Box	15,000
Outer Box Dimension (mm)	420x420x320
Max qty per Box	180,000
Weight per unit (gm)	0.0084
Weight per Reel (kg)	-
Note/Comments	

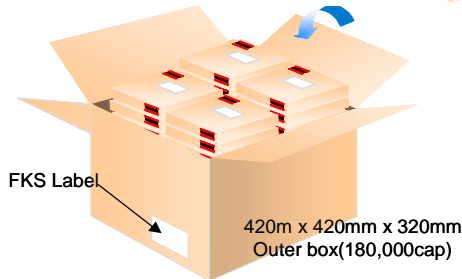
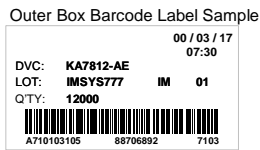
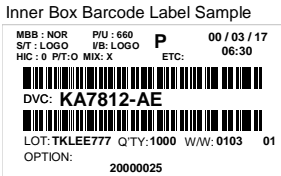
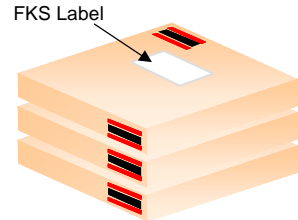
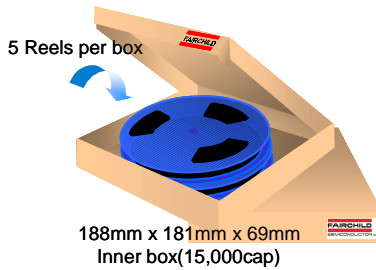

**SOT-23 Tape Leader and Trailer Configuration: Figure 2.0**

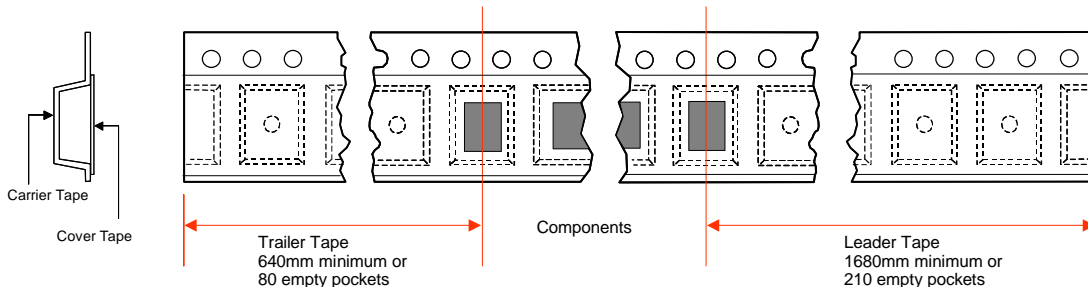

# SOT-23 Tape and Reel Data, continued

## SOT-23 Embossed Carrier Tape Configuration: Figure 3.0

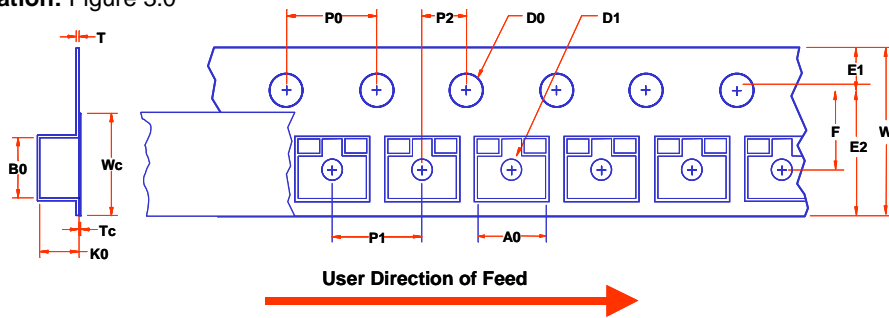

Notes: A0, B0, and K0 dimensions are determined with respect to the EIA/Jedec RS-481 rotational and lateral movement requirements (see sketches A, B, and C).



Sketch A (Side or Front Sectional View)  
Component Rotation

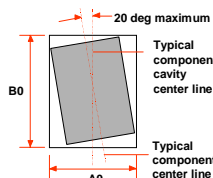

Sketch B (Top View)  
Component Rotation

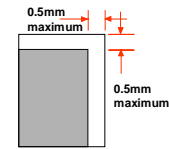

Sketch C (Top View)  
Component lateral movement

## SOT-23 Reel Configuration: Figure 4.0

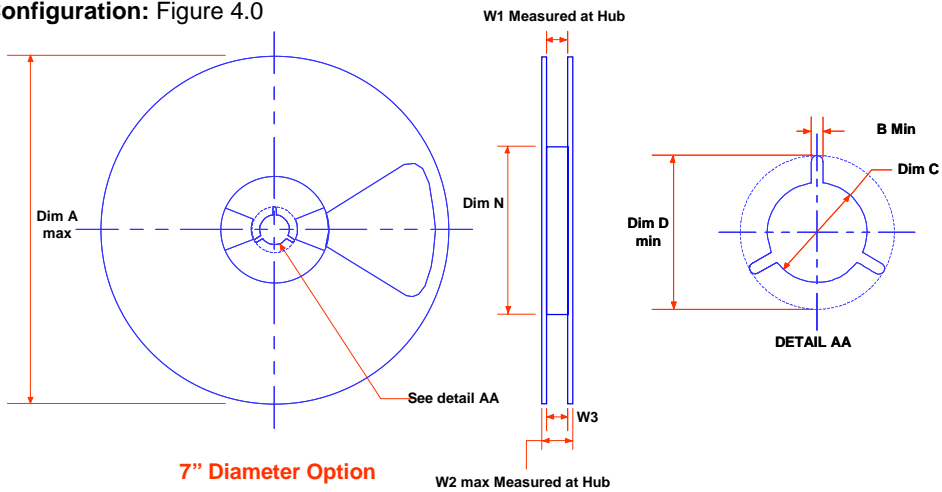

Dimensions are in inches and millimeters									
Tape Size	Reel Option	Dim A	Dim B	Dim C	Dim D	Dim N	Dim W1	Dim W2	Dim W3 (LSL-USL)
8.0mm	7" Dia	7.00 177.8	0.059 1.5	0.512 +0.020/-0.008 13 +0.5/-0.2	0.795 20.2	2.165 55	0.331 +0.059/-0.000 8.4 +1.5/0	0.567 14.4	0.311 - 0.429 7.9 - 10.9



# SOT-23 Package Dimensions



## SOT-23 (FS PKG CODE AU)

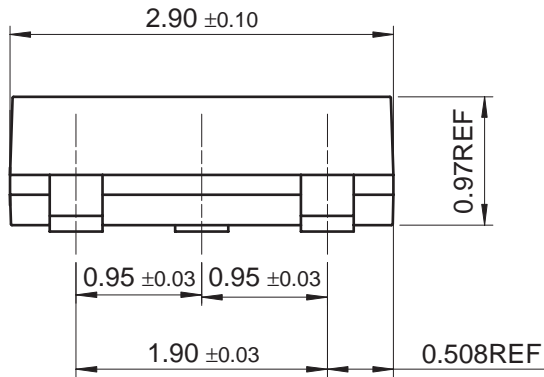
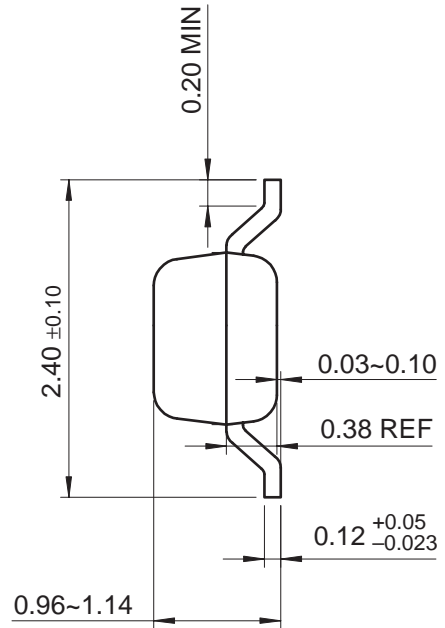
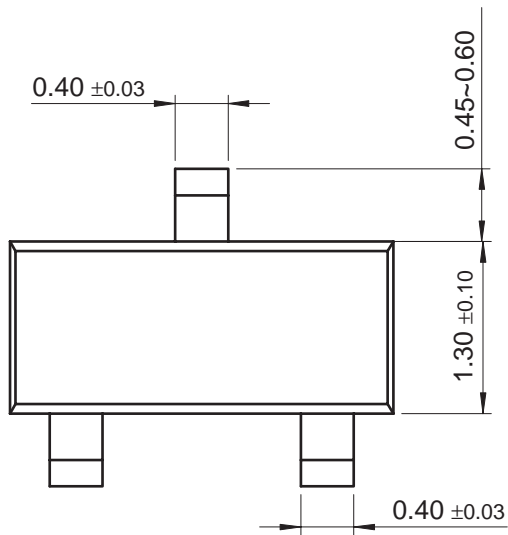

Dimensions in Millimeters

August 1999, Rev B

# SOT-223 Tape and Reel Data



## SOT-223 Packaging Configuration: Figure 1.0

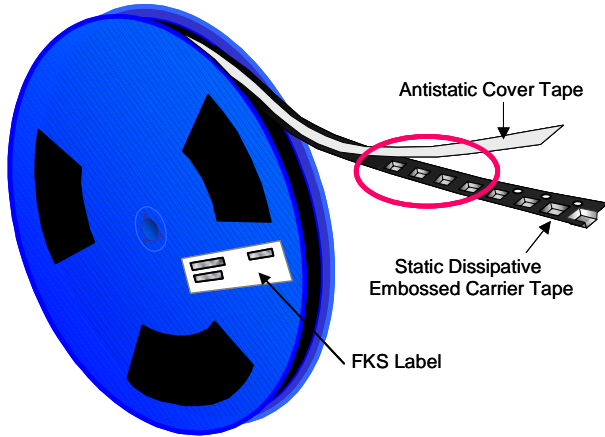

### Packaging Description:

SOT-223 parts are shipped in tape. The carrier tape is made from a dissipative (carbon filled) polycarbonate resin. The cover tape is a multilayer film (Heat Activated Adhesive in nature) primarily composed of polyester film, adhesive layer, sealant, and anti-static sprayed agent. These reeled parts in standard option are shipped with 4000 units per 13" or 330cm diameter reel. The reels are dark blue or black in color and is made of polystyrene plastic (anti-static coated). This and some other options are further described in the Packaging Information table. These full reels are individually barcode labeled and placed inside a standard intermediate box (illustrated in figure 1.0) made of recyclable corrugated brown paper. One box contains four reels maximum. And these boxes are placed inside a barcode labeled shipping box which comes in different sizes depending on the number of parts shipped.

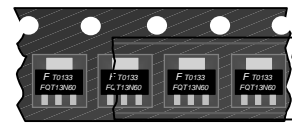

### SOT-223 Unit Orientation

SOT-223 Packaging Information	
Packaging Option	Standard
Packaging type	TNR
Qty per Reel/Tube/Bag	4,000
Reel Size	13" Dia
Inner Box Dimension (mm)	339x352x68
Max qty per Box	16,000
Outer Box Dimension (mm)	420x420x320
Max qty per Box	64,000
Weight per unit (gm)	0.1118
Weight per Reel(kg)	-
Note/Comments	

4 Reels per box

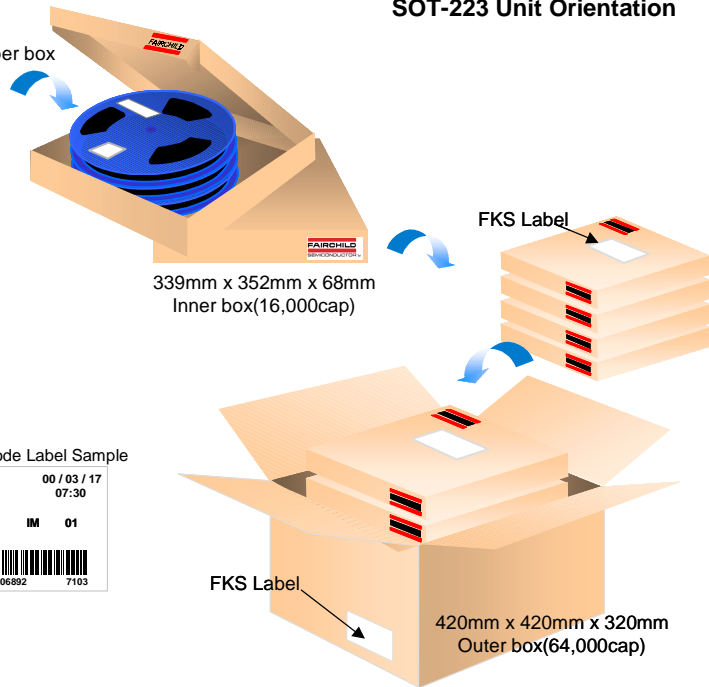

### Inner Box Barcode Label Sample



### Outer Box Barcode Label Sample



## SOT-223 Tape Leader and Trailer Configuration: Figure 2.0

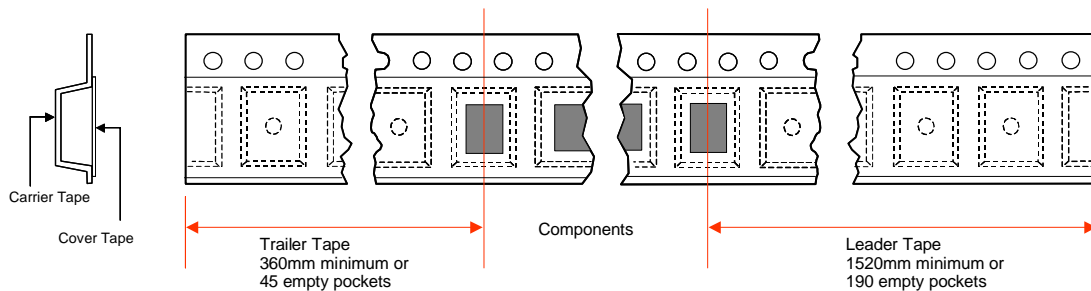

# SOT-223 Tape and Reel Data, continued

## SOT-223 Embossed Carrier Tape

Configuration: Figure 3.0

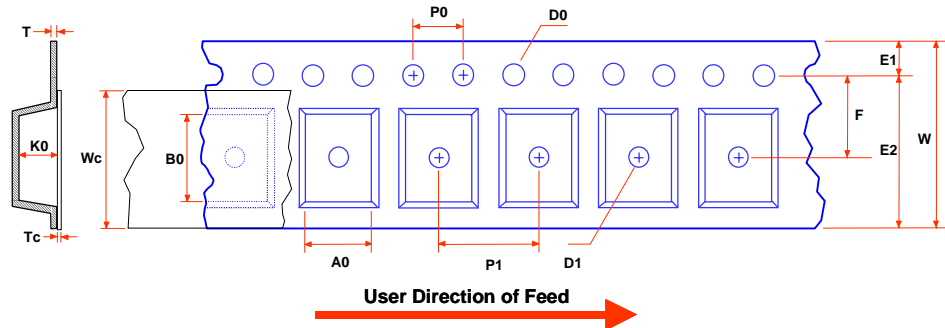

Dimensions are in millimeter														
Pkg type	A0	B0	W	D0	D1	E1	E2	F	P1	P0	K0	T	Wc	Tc
<b>SOT-223 (12mm)</b>	6.83 +/-0.10	7.42 +/-0.10	12.0 +/-0.2	1.55 +/-0.05	1.50 +/-0.10	1.75 +/-0.10	10.25 min	5.50 +/-0.05	8.0 +/-0.1	4.0 +/-0.1	1.80 +/-0.10	0.30 +/-0.05	9.50 +/-0.1	0.10 max

Notes: A0, B0, and K0 dimensions are determined with respect to the EIA/Jedec RS-481 rotational and lateral movement requirements (see sketches A, B, and C).

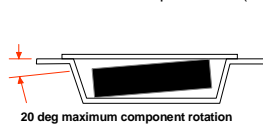

Sketch A (Side or Front Sectional View)  
Component Rotation

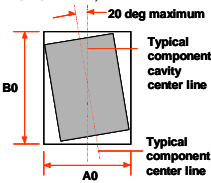

Sketch B (Top View)  
Component Rotation

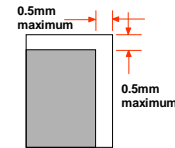

Sketch C (Top View)  
Component lateral movement

## SOT-223 Reel

Configuration: Figure 4.0

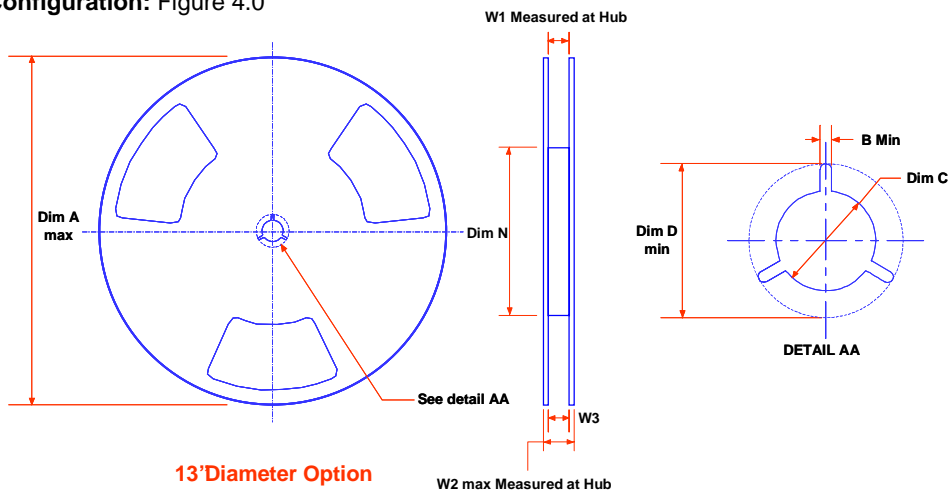

Dimensions are in inches and millimeters									
Tape Size	Reel Option	Dim A	Dim B	Dim C	Dim D	Dim N	Dim W1	Dim W2	Dim W3 (LSL-USL)
12.0mm	13'Dia	13.00 330	0.059 1.5	0.512 +0.020/-0.008 13 +0.5/-0.2	0.795 20.2	4.00 100	0.488 +0.078/-0.000 12.4 +2/0	0.724 18.4	0.468 -0.606 11.9 -15.4

# SOT-223 Package Dimensions



## SOT-223 (FS PKG CODE AV)

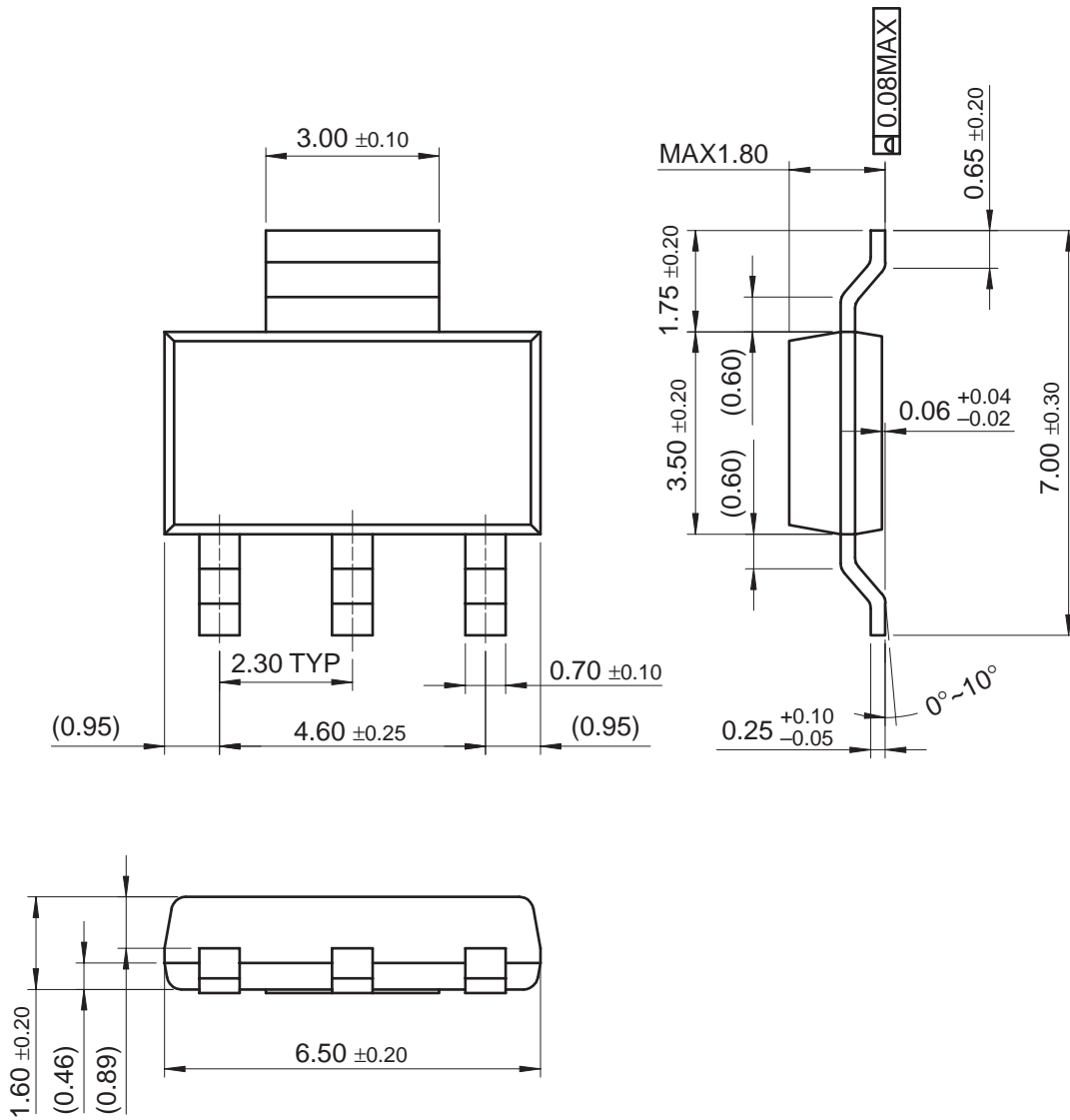

Dimensions in Millimeters

August 1999, Rev B

## TRADEMARKS

The following are registered and unregistered trademarks Fairchild Semiconductor owns or is authorized to use and is not intended to be an exhaustive list of all such trademarks.

ACE <sub>x</sub> <sup>TM</sup>	FAST <sup>®</sup>	OPTOLOGIC <sup>TM</sup>	SMART START <sup>TM</sup>	VCX <sup>TM</sup>
Bottomless <sup>TM</sup>	FAST <sub>r</sub> <sup>TM</sup>	OPTOPLANAR <sup>TM</sup>	STAR*POWER <sup>TM</sup>	
CoolFET <sup>TM</sup>	FRFET <sup>TM</sup>	PACMAN <sup>TM</sup>	Stealth <sup>TM</sup>	
CROSSVOLT <sup>TM</sup>	GlobalOptoisolator <sup>TM</sup>	POP <sup>TM</sup>	SuperSOT <sup>TM</sup> -3	
DenseTrench <sup>TM</sup>	GTO <sup>TM</sup>	Power247 <sup>TM</sup>	SuperSOT <sup>TM</sup> -6	
DOMET <sup>TM</sup>	HiSeC <sup>TM</sup>	PowerTrench <sup>®</sup>	SuperSOT <sup>TM</sup> -8	
EcoSPARK <sup>TM</sup>	ISOPLANAR <sup>TM</sup>	QFET <sup>TM</sup>	SyncFET <sup>TM</sup>	
E <sup>2</sup> CMOS <sup>TM</sup>	LittleFET <sup>TM</sup>	QST <sup>TM</sup>	TinyLogic <sup>TM</sup>	
EnSigna <sup>TM</sup>	MicroFET <sup>TM</sup>	QT Optoelectronics <sup>TM</sup>	TruTranslation <sup>TM</sup>	
FACT <sup>TM</sup>	MicroPak <sup>TM</sup>	Quiet Series <sup>TM</sup>	UHC <sup>TM</sup>	
FACT Quiet Series <sup>TM</sup>	MICROWIRE <sup>TM</sup>	SILENT SWITCHER <sup>®</sup>	UltraFET <sup>®</sup>	

STAR\*POWER is used under license

## DISCLAIMER

FAIRCHILD SEMICONDUCTOR RESERVES THE RIGHT TO MAKE CHANGES WITHOUT FURTHER NOTICE TO ANY PRODUCTS HEREIN TO IMPROVE RELIABILITY, FUNCTION OR DESIGN. FAIRCHILD DOES NOT ASSUME ANY LIABILITY ARISING OUT OF THE APPLICATION OR USE OF ANY PRODUCT OR CIRCUIT DESCRIBED HEREIN; NEITHER DOES IT CONVEY ANY LICENSE UNDER ITS PATENT RIGHTS, NOR THE RIGHTS OF OTHERS.

## LIFE SUPPORT POLICY

FAIRCHILD'S PRODUCTS ARE NOT AUTHORIZED FOR USE AS CRITICAL COMPONENTS IN LIFE SUPPORT DEVICES OR SYSTEMS WITHOUT THE EXPRESS WRITTEN APPROVAL OF FAIRCHILD SEMICONDUCTOR CORPORATION.

As used herein:

1. Life support devices or systems are devices or systems which, (a) are intended for surgical implant into the body, or (b) support or sustain life, or (c) whose failure to perform when properly used in accordance with instructions for use provided in the labeling, can be reasonably expected to result in significant injury to the user.
2. A critical component is any component of a life support device or system whose failure to perform can be reasonably expected to cause the failure of the life support device or system, or to affect its safety or effectiveness.

## PRODUCT STATUS DEFINITIONS

### Definition of Terms

Datasheet Identification	Product Status	Definition
Advance Information	Formative or In Design	This datasheet contains the design specifications for product development. Specifications may change in any manner without notice.
Preliminary	First Production	This datasheet contains preliminary data, and supplementary data will be published at a later date. Fairchild Semiconductor reserves the right to make changes at any time without notice in order to improve design.
No Identification Needed	Full Production	This datasheet contains final specifications. Fairchild Semiconductor reserves the right to make changes at any time without notice in order to improve design.
Obsolete	Not In Production	This datasheet contains specifications on a product that has been discontinued by Fairchild semiconductor. The datasheet is printed for reference information only.